

FasCal

Fastest[®]
Your Productivity Connection

CALIBRATE **5 TIMES FASTER!**

- ✓ Transmitters
- ✓ Control Valves
- ✓ Transducers
- ✓ Pressure Gauges
- ✓ Compression Fittings
- ✓ Conduit / Piping

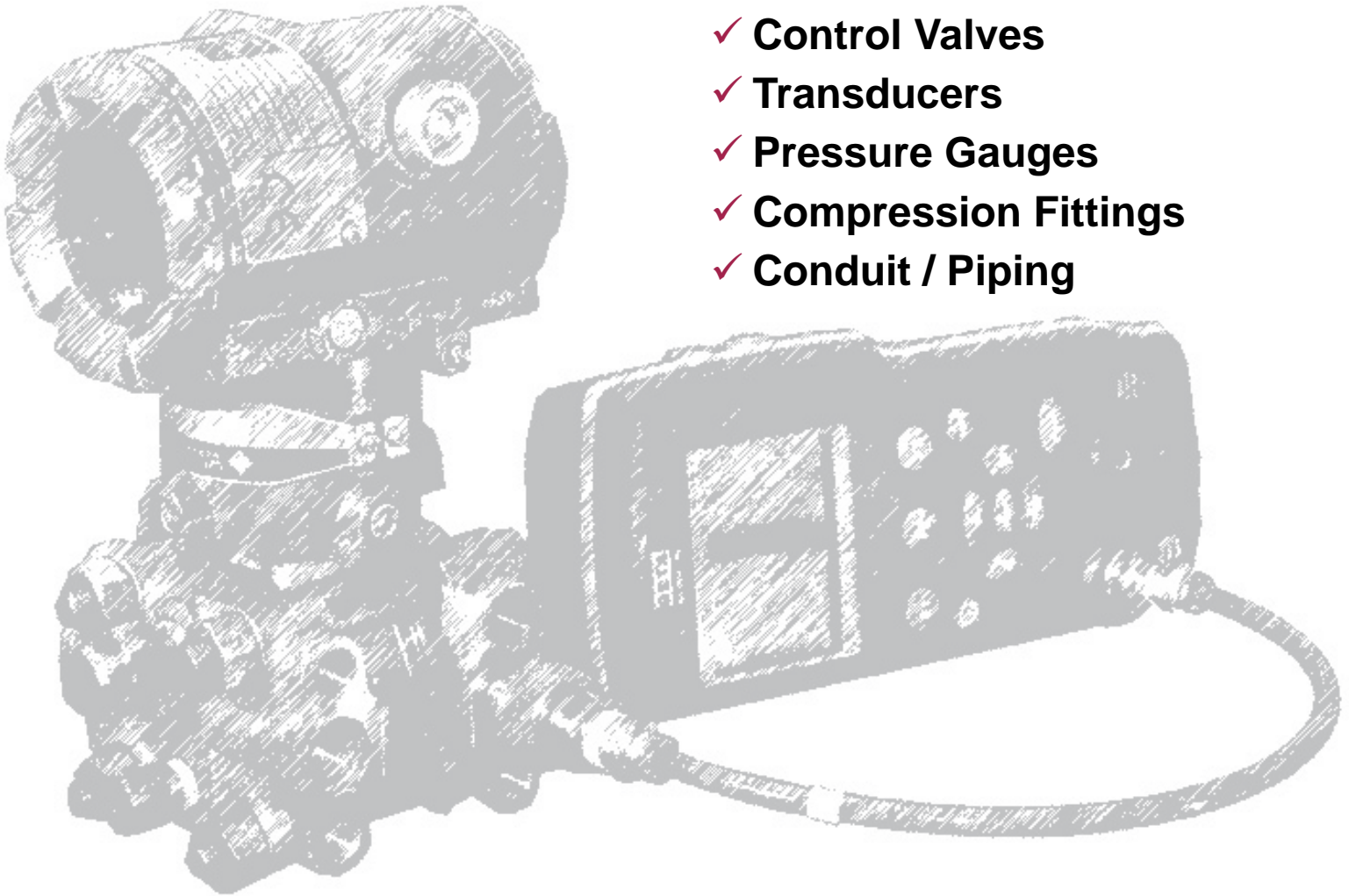

Calibration Connection Tools

No Thread Damage, Wrenches or Pipe Sealant

FasTest's complete line of calibration connection tools feature a patented pressure assisted grip and seal technology that provide leak tight connections, resulting in the highest level of accuracy in the fastest time possible. The ergonomically designed connection tools improve productivity, product quality and user comfort. Choose **FasTest** calibration connection tools to eliminate sealants, thread damage and wrench tightening, and benefit from an improved calibration process and quality at reduced costs.

Connectors Designed for Calibration!

FasTest's calibration connectivity tools are specifically designed to meet the most frequent challenges or problems facing technicians that calibrate instruments such as transmitters, pressure gauges and transducers.

Calibration technician challenges:

- Calibrate a large quantity of instruments in a short period of time
- Create leak tight connections to a variety of thread profiles
- Eliminate thread damage to instruments
- Minimize contamination to process media



Calibrate Lots of Instruments - Fast!

FasTest's "plug and play" modular connectivity tools eliminate the traditional process of using tape sealant, wrenches and a bit of muscle to create leak tight connections. Comparisons of the FasTest way to traditional methods has shown at least a 5X efficiency improvement.

Connectors for the industries most common:

- Calibrators
- Valve Actuators
- Pressure Gauges
- Transducers
- Compression Fittings
- Pipe Threads



YAMATAKE

Invensys®
FOXBORO

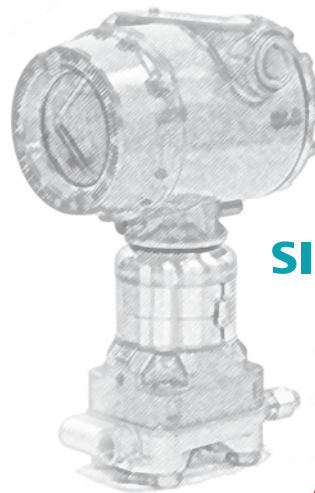

SIEMENS

ABB

smar

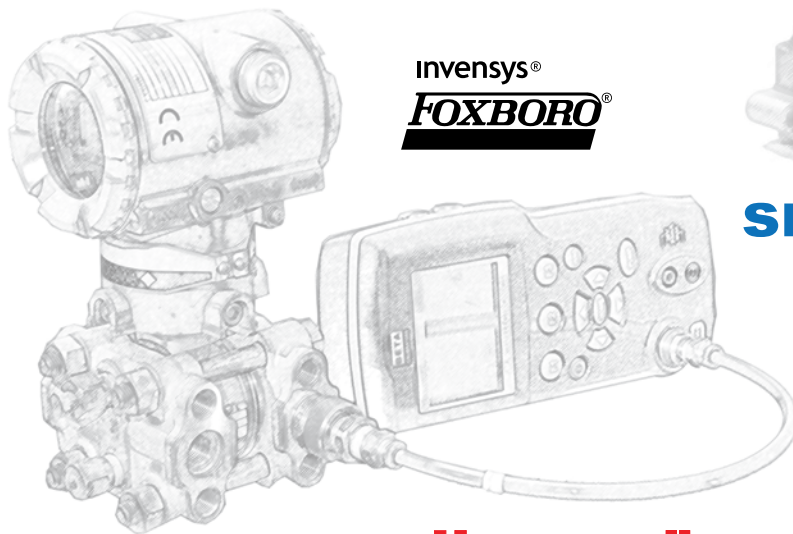

ROSEMOUNT

Honeywell

YOKOGAWA ◆



Connect to a Variety of Profiles - Fast!

Technicians are required to connect to a variety of transmitters, pressure gauges, transducers and other instruments for calibration or maintenance operations. This variety of instruments also comes with a variety of connection sizes as well as internal and external thread profiles.

FasTest transition connectors quickly solve this problem and provide fast connections to popular thread profiles.

- Assembled styles to transition from 1/8" or 1/4" male threads to 1/8", 1/4", 3/8" and 1/2" female threads
- Build your own transitions between the modular **FasCal** connection tools with hose assemblies and fittings



Safe, High Pressure Leak Tight Seals - Fast!

FasTest's patented pressure assisted grip and seal technology delivers repeatable, high pressure and safe leak tight connections. This results in the highest level of accuracy in the fastest time possible.

- Ergonomically designed connection tools improve user comfort
- Pressure rated to 4000 or 5000 psi



Eliminate Thread Damage and Contamination

Traditional methods of sealing require a combination of tape sealant, mating thread profiles and torque typically applied with wrenches. Each time a connection is taped and torqued to seal; wear or damage occurs to the mating threads. **FasTest's** grip and seal technology relies on the combination of pressure, seals and patented mechanical design to create leak tight connections.

- Eliminate tape and sealants that can contaminate process media
- Minimize thread wear and damage
- Eliminate wrenches and torquing

FasCal - Sleeve Actuated for Compression Fittings



Fastest sleeve actuated **HPB** connectors are the preferred method for fast, safe and repeatable connections to *Swagelok*® and *Ferulok*® compression fittings or other similar brands. Simply push on to fitting to connect; pull sleeve away from connection to release.

- Safety feature will not allow disconnect under pressure
- Instant connections to 5000 psi

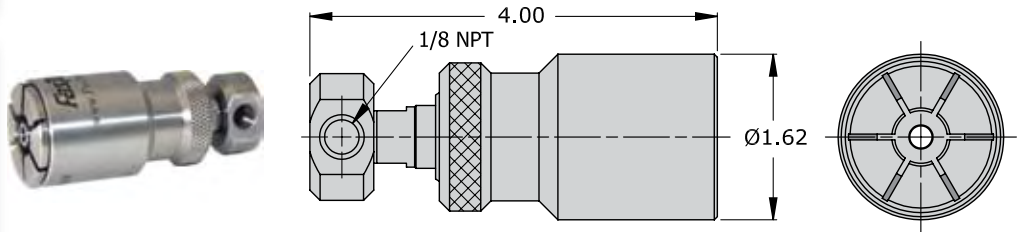

Part Number	Fitting Size	Rating PSI	Housing Material	Seal Material	Main Seals Package (5)
HPB-CF04021	1/4" (7/16-20) <i>Swagelok</i>	5000	Stainless Steel	Buna N	S1008-B70
HPB-CF06021	3/8" (9/16-20) <i>Swagelok</i>	5000			S1011-B70
HPB-CF08021	1/2" (3/4-20) <i>Swagelok</i>	5000			S1013-B70
HPB-CF04021F	1/4" (7/16-20) <i>Ferulok</i>	5000			S1008-B70
HPB-CF06021F	3/8" (9/16-18) <i>Ferulok</i>	5000			S1011-B70
HPB-CF08021F	1/2" (3/4-16) <i>Ferulok</i>	5000			S1013-B70

FasCal - "Twist to Connect" Connectors and Caps for Compression Fittings



TwistMates unique "twist to connect" and pressure assisted grip and seal delivers fast, safe and repeatable connections to *Swagelok*® style compression fittings. The connector's internal swivel allows easy installation while plumbed (connected) to a supply line. Simply twist the connector to finger tight for an instant leak tight and high pressure connection.

- Compatible to 1/4", 3/8" and 1/2" *Swagelok* style compression fittings
- Instant connections to 4000 or 5000 psi eliminates tape, sealants and wrenches
- No damage to threaded parts

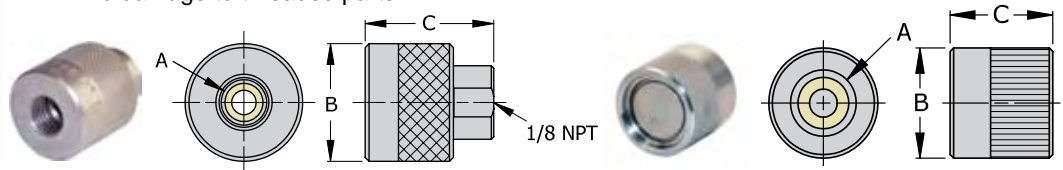

Part Number	Thread Size Dim "A"	Diameter Dim "B"	Length Dim "C"	Rating PSI	Housing Style	Housing Material	Seal Material	Main Seals Package (5)
MET-CF04021	1/4" (7/16-20)	0.95"	1.63"	5000	Swivel	Stainless Steel	Urethane	S1008-B70
MET-CF06021	3/8" (9/16-20)	1.20"	1.31"	4000				S1011-B70
MET-CF08021	1/2" (3/4-20)	1.38"	1.46"	4000				S1013-B70
MET-CF04C	1/4" (7/16-20)	0.95"	0.88"	5000	Cap	Stainless Steel	Urethane	S1008-B70
MET-CF06C	3/8" (9/16-20)	1.20"	0.90"	4000				S1011-B70
MET-CF08C	1/2" (3/4-20)	1.38"	0.97"	4000				S1013-B70

FasCal - Lever Actuated for 1/4" IEC Transmitter Ports and 1/4" NPT



FasTest lever actuated connectors are an ideal method for fast, safe and repeatable connections to all types of transmitters. Simply squeeze the lever and insert into 1/4" threaded port; release lever for an instant leak tight and high pressure connection.

- Compatible to 1/4" NPT and 1/4" (IEC 61518) 2.126 (54) process flange ports
- Instant connections to 5000 psi eliminates tape, sealants and wrenches
- No damage to threaded parts

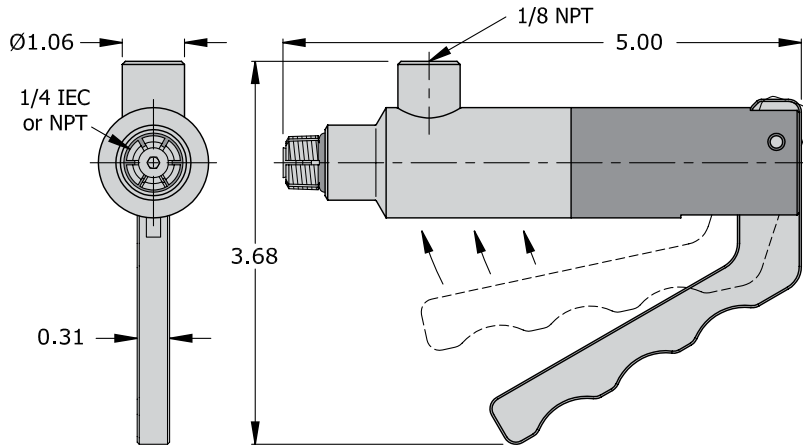

Part Number	Thread Size	Rating PSI	Housing Material	Seal Material	Main Seals Package (5)
L042021TM	1/4" NPT	5000	Stainless Steel	Buna N	SL042-B

FasCal - "Twist to Connect" Connectors for 1/4" IEC Transmitter Ports



TwistMates unique "twist to connect" and pressure assisted grip and seal delivers fast, safe and repeatable connections. The connector's internal swivel also allows easy installation while plumbed (connected) to a supply line. Simply twist the connector to finger tight for an instant leak tight and high pressure connection.

- Compatible to 1/4" (IEC 61518) 2.126 (54) process flange ports
- Instant connections to 5000 psi eliminates tape, sealants and wrenches
- No damage to threaded parts

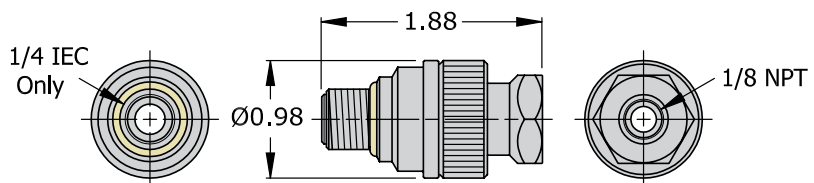

Part Number	Thread Size	Rating PSI	Housing Style	Housing Material	Seal Material	Main Seals Package (5)
MIT-042021TM	1/4" IEC	5000	Swivel	Stainless Steel	Urethane	S1111-U70

FasCal - Sleeve Actuated Connectors for NPT Male Threads



Fastest sleeve actuated **HPB** connectors are the preferred method for fast, safe and repeatable connections to 1/4", 3/8" and 1/2" male NPT threads. Simply push on to fitting to connect; pull sleeve away from connection to release.

- Safety feature will not allow disconnect under pressure
- Instant connections to 5000 psi eliminates tape, sealants and wrenches
- No damage to threaded parts during calibration

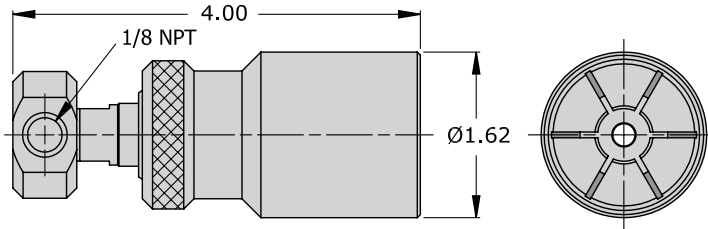

Part Number	Thread Size	Rating PSI	Housing Material	Seal Material	Main Seals Package (5)
HPB-041021	1/4" NPT	5000	Stainless Steel	Buna N	S1008-B70
HPB-061021	3/8" NPT	5000			S1011-B70
HPB-081021	1/2" NPT	5000			S1013-B70

FasCal - "Twist to Connect" Connectors for MIL Spec 18997 Threads



TwistMates unique "twist to connect" and pressure assisted grip and seal delivers fast, safe and repeatable threaded connections. Simply twist the connector to finger tight for an instant leak tight and high pressure connection.

- Instant connections to 4000 psi eliminates tape, sealants and wrenches
- Internal swivel allows easy installation while connected to a supply line
- No damage to threaded parts

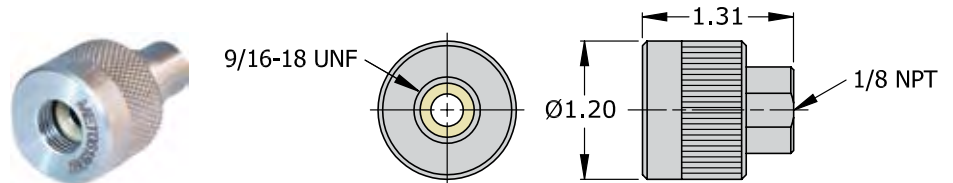

Part Number	Thread Size	Rating PSI	Housing Style	Housing Material	Seal Material	Main Seals Package (5)
MET-06-18997-021	9/16-18 MIL Spec 18997	4000	Swivel	Stainless Steel	Urethane	S1109-U70

FasCal - "Twist to Connect" Connectors for NPT Male Threads



TwistMates unique "twist to connect" and pressure assisted grip and seal delivers fast, safe and repeatable threaded connections. Simply twist the connector to finger tight for an instant leak tight and high pressure connection.

- Compatible to 1/8", 1/4", 3/8" and 1/2" male NPT threads
- Cap versions available for bleeding transmitter impulse lines
- Instant connections to 4000 or 5000 psi eliminates tape, sealants and wrenches
- Internal swivel allows easy installation while connected to a supply line
- No damage to threaded parts

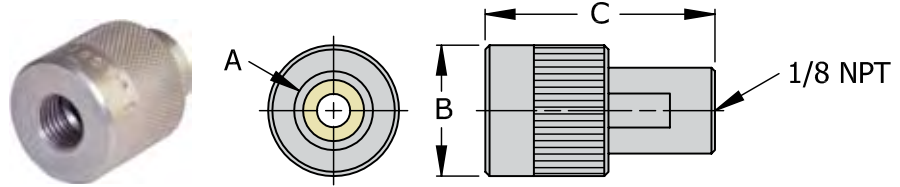

Part Number	Thread Size Dim "A"	Diameter Dim "B"	Length Dim "C"	Rating PSI	Housing Style	Housing Material	Seal Material	Main Seals Package (5)
MET-021021	1/8" NPT	0.80"	1.62"	5000	Swivel	Stainless Steel	Urethane	S1105-U70
MET-041021	1/4" NPT	0.93"	1.63"	5000				S1108-U70
MET-061021	3/8" NPT	1.20"	1.31"	4000				S1110-U70
MET-081021	1/2" NPT	1.36"	1.46"	4000				S1112-U70

Contact factory for higher pressure ratings.

FasCal - "Twist to Connect" Caps for NPT Male Threads

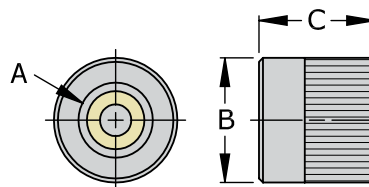

Part Number	Thread Size Dim "A"	Diameter Dim "B"	Length Dim "C"	Rating PSI	Housing Style	Housing Material	Seal Material	Main Seals Package (5)
MET-021C	1/8" NPT	0.80"	0.83"	5000	Cap	Stainless Steel	Urethane	S1105-U70
MET-041C	1/4" NPT	0.93"	0.88"	5000				S1108-U70
MET-061C	3/8" NPT	1.20"	0.90"	4000				S1110-U70
MET-081C	1/2" NPT	1.36"	0.97"	4000				S1112-U70

FasCal - "Twist to Connect" Connectors for NPT Female Threads



TwistMates unique "twist to connect" and pressure assisted grip and seal delivers fast, safe and repeatable threaded connections. Simply twist the connector to finger tight for an instant leak tight and high pressure connection.

- Compatible to 1/8", 1/4", 3/8" and 1/2" female NPT threads
- Plug versions are also available to quickly seal a threaded port
- Instant connections to 4000 or 5000 psi eliminates tape, sealants and wrenches
- Internal swivel allows easy installation while connected to a supply line
- No damage to threaded parts

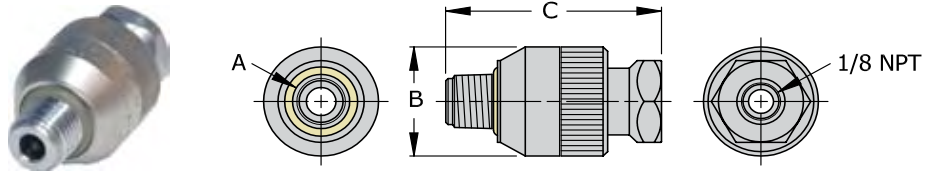

Part Number	Thread Size Dim "A"	Diameter Dim "B"	Length Dim "C"	Rating PSI	Housing Style	Housing Material	Seal Material	Main Seals Package (5)
MIT-022021	1/8" NPT	0.81"	1.69"	5000	Swivel	Stainless Steel	Urethane	S1109-U70
MIT-042021	1/4" NPT	1.00"	1.88"	5000				S1111-U70
MIT-062021	3/8" NPT	1.18"	2.09"	4000				S1113-U70
MIT-082021	1/2" NPT	1.36"	2.57"	4000				S1209-U70

Contact factory for higher pressure ratings.

FasCal - "Twist to Connect" Plugs for NPT Female Threads

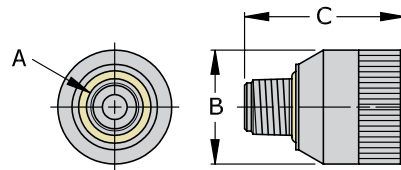

Part Number	Thread Size Dim "A"	Diameter Dim "B"	Length Dim "C"	Rating PSI	Housing Style	Housing Material	Seal Material	Main Seals Package (5)
MIT-022P	1/8" NPT	0.81"	1.24"	5000	Plug	Stainless Steel	Urethane	S1109-U70
MIT-042P	1/4" NPT	1.00"	1.41"	5000				S1111-U70
MIT-062P	3/8" NPT	1.18"	1.49"	4000				S1113-U70
MIT-082P	1/2" NPT	1.36"	1.85"	4000				S1209-U70

FasCal - High Pressure Transition Connectors



TwistMates modular design is ideal for combining to transition from one thread profile to another to deliver the same features found with individual connectors. Save more time with assembled transition connectors from **FasTest** when instrument calibration time is critical.

- 1/8" male to 1/8", 1/4", 3/8" and 1/2" female NPT threads
- 1/4" male to 1/8", 1/4", 3/8" and 1/2" female NPT threads
- Instant connections to 4000 or 5000 psi eliminates tape, sealants and wrenches
- Internal swivel allows easy installation while connected to a supply line
- No damage to threaded parts

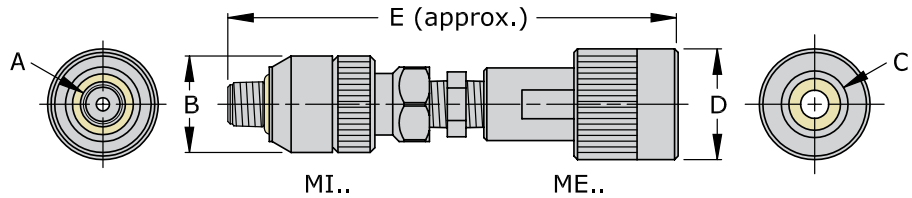

Part Number	Thd. Size Dim "A"	Dia. Dim "B"	Thd. Size Dim "C"	Dia. Dim "D"	Length Dim "E"	Rating PSI	Housing Style	Housing Material	Seal Material	MI .. Main Seals Package (5)	ME .. Main Seals Package (5)
MI022-ME021	1/8" NPT	0.81"	1/8" NPT	0.80"	3.74"	5000	Swivel	Stainless Steel	Urethane	S1109-U70	S1105-U70
MI022-ME041			1/4" NPT	0.93"	3.78"	5000					S1108-U70
MI022-ME061			3/8" NPT	1.20"	3.46"	4000					S1110-U70
MI022-ME081			1/2" NPT	1.36"	3.61"	4000					S1112-U70
MI042-ME021	1/4" NPT	1.00"	1/8" NPT	0.80"	3.95"	5000	Swivel	Stainless Steel	Urethane	S1111-U70	S1105-U70
MI042-ME041			1/4" NPT	0.93"	3.97"	5000					S1108-U70
MI042-ME061			3/8" NPT	1.20"	3.65"	4000					S1110-U70
MI042-ME081			1/2" NPT	1.36"	3.80"	4000					S1112-U70

FasCal - High Pressure Adapter Fitting



Build your own transition connectors. Make any combination by selecting two **FasCal** connection tools to join together with 1/8" male to 1/8" male adapter fitting. Additional options are hose assemblies featured on page 10.

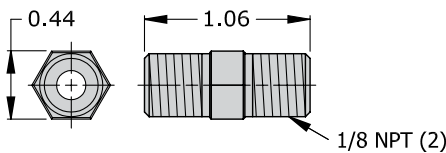

Part Number	Thread Size	Rating PSI
APN022	1/8" NPT Male to 1/8" NPT Male	5000

FasCal - High Pressure Hose Assemblies



Fastest high pressure hose assemblies are ideal for fast, modular connections in small hard to reach places where instrument calibration is necessary.

- 1/8" male to 1/8" male NPT threads mate to any **FasCal** connector
- Available in convenient 18, 36 and 72" lengths
- Pressure rated to 2500 psi

Part Number	Hose Length	Rating PSI	Hose Material	Connector Material
HP022X18	18 Inches	2500	SynFlex	Steel
HP022X36	36 Inches	2500	SynFlex	Steel
HP022X72	72 Inches	2500	SynFlex	Steel

FasCal - Basic Calibration Kit (FSC01)



FSC01

The **FasCal** Basic Calibration Kit includes basic connectors needed to instantly improve your calibration throughput of transmitters, control valves and pressure sensing instruments and is ideal for every service vehicle in your fleet.

The FSC01 kit includes the products listed below.

Part Number	Description	Specifications	Main Seals Package (5)
MIT-022021	1/8" Male NPT Swivel Connector	Page 8	S1109-U70
MIT-042021	1/4" Male NPT Swivel Connector		S1111-U70
MIT-082021	1/2" Male NPT Swivel Connector		S1209-U70
MIT-042021TM	1/4" Male NPT Swivel Connector for IEC Transmitter Ports	Page 5	S1111-U70
MET-021021	1/8" Female NPT Swivel Connector	Page 7	S1105-U70
MET-041021	1/4" Female NPT Swivel Connector		S1108-U70
MET-081021	1/2" Female NPT Swivel Connector		S1112-U70
FCC01	Plastic Tote Case		
STR012	Seal Service Tool		

FasCal - Master Lab Calibration Kit (FSC02)



The **FasCal** Master Lab Calibration Kit includes practically every connector needed for your calibration shop or service vehicle needs. The popular sleeve and lever actuated connectors combined with the “*twist to connect*” family of transition connectors are ideal for high volume efficient calibration of transmitters, gauges, control valves and pressure sensing instruments. FSC02 kit includes the products listed below.

	Part Number	Description	Specifications		Part Number
Compression	HPB-CF04021	1/4" (7/16-20) Sleeve Actuated Connector for <i>Swagelok</i>	Page 4	Replacement Seal Sets	S1008-B70
	MET-CF04021	1/4" (7/16-20) Connector for <i>Swagelok</i>			S1011-B70
	MET-CF06021	3/8" (9/16-20) Connector for <i>Swagelok</i>			S1013-B70
	MET-CF08021	1/2" (3/4-20) Connector for <i>Swagelok</i>			S1105-U70
	MET-CF04C	1/4" (7/16-20) Cap for <i>Swagelok</i>			S1108-U70
	MET-CF06C	3/8" (9/16-20) Cap for <i>Swagelok</i>			S1109-U70
	MET-CF08C	1/2" (3/4-20) Cap for <i>Swagelok</i>			S1110-U70
IEC	L042021TM	1/4" Male NPT Lever Actuated Connector	Page 5		S1111-U70
	MIT-042021TM	1/4" Male NPT Swivel Connector			S1112-U70
Female Threads	MET-021021	1/8" Female NPT Swivel Connector	Page 7		S1113-U70
	MET-041021	1/4" Female NPT Swivel Connector			S1209-U70
	MET-061021	3/8" Female NPT Swivel Connector			LS042B
	MET-081021	1/2" Female NPT Swivel Connector			
	MET-021C	1/8" Female NPT Cap			
	MET-041C	1/4" Female NPT Cap			
	MET-061C	3/8" Female NPT Cap			
	MET-081C	1/2" Female NPT Cap			
Male Threads	MIT-022021	1/8" Male NPT Swivel Connector	Page 8		
	MIT-042021	1/4" Male NPT Swivel Connector			
	MIT-062021	3/8" Male NPT Swivel Connector			
	MIT-082021	1/2" Male NPT Swivel Connector			
	MIT-022P	1/8" Male NPT Plug			
	MIT-042P	1/4" Male NPT Plug			
	MIT-062P	3/8" Male NPT Plug			
Male \ Female Adapters	MI022-ME021	1/8" Male to 1/8" Female Swivel Connector	Page 9		
	MI022-ME041	1/8" Male to 1/4" Female Swivel Connector			
	MI022-ME061	1/8" Male to 3/8" Female Swivel Connector			
	MI022-ME081	1/8" Male to 1/2" Female Swivel Connector			
	MI042-ME021	1/4" Male to 1/8" Female Swivel Connector			
	MI042-ME041	1/4" Male to 1/4" Female Swivel Connector			
	MI042-ME061	1/4" Male to 3/8" Female Swivel Connector			
	MI042-ME081	1/4" Male to 1/2" Female Swivel Connector			
Access.	APN022	1/8" Male to 1/8" Male Fitting	Page 10		
	HP022X036	1/8" Male to 1/8" Male 36" Hose Assembly			
	FCC02	Plastic Cabinet Case			
	STR012	Seal Service Tool			

Additional Products and Brochures from FasTest



Engineering & Application Guide

Engineering and Application Guide to Connectors for Pressure Testing & Processing details our complete offering for all applications.



Medical Connectors

Versatile product line of connectors for sealing and testing a wide variety of medical products and drug delivery devices.



Refrigeration Connectors

The **CoreMax** system of high flow processing valves and connectors for the refrigeration manufacturing and service industry.

Additional Options and Services from FasTest

ReConnect - Our connector refurbishment program ensures proper connector operation and performance as well as extending the service life and warranty of your investment. Connectors routinely maintained can be refurbished economically relative the cost of a new connector replacement. Contact **FasTest** for details.

Custom Applications - Customized products are available for unusual or unique connection requirements.

High Pressure Connectors - Optional connectors are available for pressures up to 10,000 psi. Contact **FasTest** for details.

Limited Express Warranty

FasTest Inc. warrants its products against defects in workmanship and materials for 12 months from the date of sale by FasTest Inc. or its authorized distributor. This warranty is void if the product is misused, tampered with or used in a manner that is contrary to FasTest Inc.'s written recommendations and/or instructions.

FasTest Inc. does not warrant the suitability of the product for any particular application. Determining product application suitability is solely the customer's responsibility. FasTest Inc. is not liable for consequential or other damages including, but not limited to, loss, damage, personal injury, or any other expense directly or indirectly arising from the use of or inability to use its products either separately or in combination with other products.

ALL OTHER WARRANTIES EXPRESS OR IMPLIED, WHETHER ORAL, WRITTEN OR IN ANY OTHER FORM, INCLUDING BUT NOT LIMITED TO WARRANTIES OF MERCHANTABILITY OR FITNESS FOR A PARTICULAR PURPOSE ARE EXPRESSLY EXCLUDED.

The sole and exclusive remedy under this warranty is limited to replacement of the product or an account credit in the amount of the original selling price, at the option of FasTest Inc. All allegedly defective products must be returned prepaid transportation to FasTest Inc., together with information describing the product's performance, unless disposition in the field is authorized in writing by FasTest Inc.

Notifications and Copyright

Specifications in this brochure are subject to change without notice. FasTest also reserves the right to make modifications and makes no guarantee of the accuracy of the information contained herein.

© 2009 FasTest Inc. All rights reserved. No part of this publication may be reproduced with written without permission.

Viditec

Humberto I 2887 / 89
C1231ACE- Ciudad Autónoma de Buenos Aires
Tel.: +54 11 4308 - 4884 / Fax: +54 11 4308 - 5493
info@viditec.com.ar - www.viditec.com